



F4 2010-2020

FITTING INSTRUCTIONS TO BE FITTED BY A QUALIFIED TECHNICIAN



THIS SHEET INCLUDES FITTING INSTRUCTIONS FOR THE FOLLOWING PARTS:

Secondary Alternator Cover Part No. EC-F4-2012-1-GBR / Secondary Clutch Cover Part No. EC-F4-2012-2-GBR



SECONDARY ALTERNATOR COVER PART NO. EC-F4-2012-1-GBR

- 1 Remove the middle fairing section using the 9 Zeus fasteners.
- 2 Remove the 4 existing bolts from the stock aluminium Alternator cover, shown as position Bolt 1, 2, 3 & 4.
- 3 Place the Secondary Alternator Cover over the stock aluminium cover.
- 4 Loosely screw down all bolts using the supplied M6 x 30mm replacement bolts.
- 5 Tighten bolts to a Torque of 11 Nm as per Manufacturer's recommendations.
DO NOT OVERTIGHTEN.
- 6 Refit the Fairing.

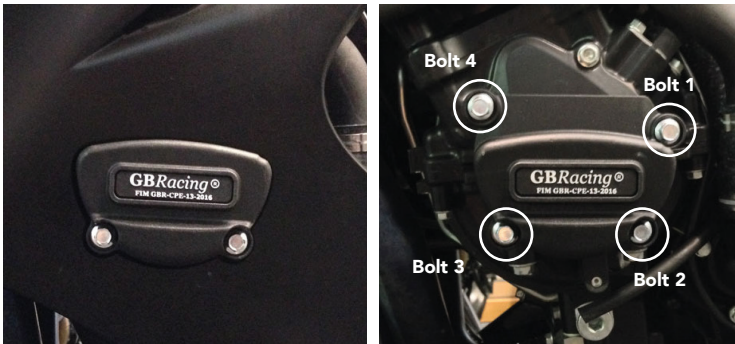

SECONDARY CLUTCH COVER PART NO. EC-F4-2012-2-GBR

- 1 Remove the RHS fairing panel via the Dzus fasteners.
 - 2 Remove 4 existing bolts from the stock Clutch cover, shown as position Bolt 1, 2, 3 & 4.
 - 3 Place the Secondary Clutch Cover over the stock cover.
 - 4 Assemble 4 replacement bolts loosely in the correct position as shown.
 - 5 Tighten bolts to a Torque of 8 Nm as per manufacturer's recommendations.
 - 6 Replace fairing panel.
- DO NOT OVERTIGHTEN.

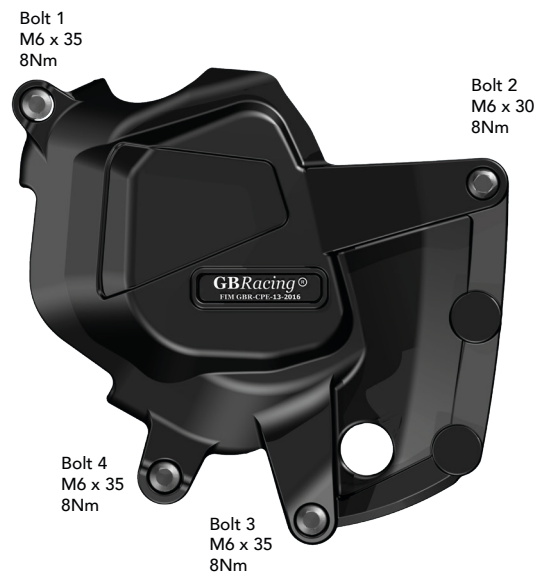
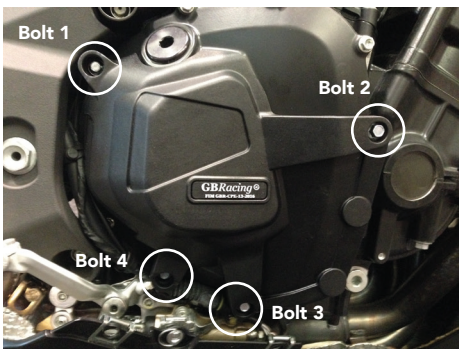

Engine Cover Set: EC-F4-2012-SET-GBR
EC-F4-2012-1-GBR, EC-F4-2012-2-GBR

www.GBRacing.eu

DO NOT use these products unless you agree to our Terms & Conditions, as shown on our paperwork and website. If you do not agree, please return the product(s) to your dealer for a refund.